



Inodoro inteligente
Neo Bath S-Trap

ZT500-PSD-BL



Detalle Técnico	
Doble descarga	Descarga parcial: 4,1lts
	Descarga total: 6,0 lts
Distancia a la pared	305mm
Electronic seat	Sí
Colores	Blanco
Conexión de entrada de agua	1/2"
Conexión eléctrica	110 volt
Herrajes	Incluidos
Pernos de fijación a piso	Incluidos
Anillo de cera	No Incluido
Flexible + llave angular	No incluidos

Dimensiones	
Tolerancias dimensionales	≥ 200 mm al 5%
	< 200 mm al 3%

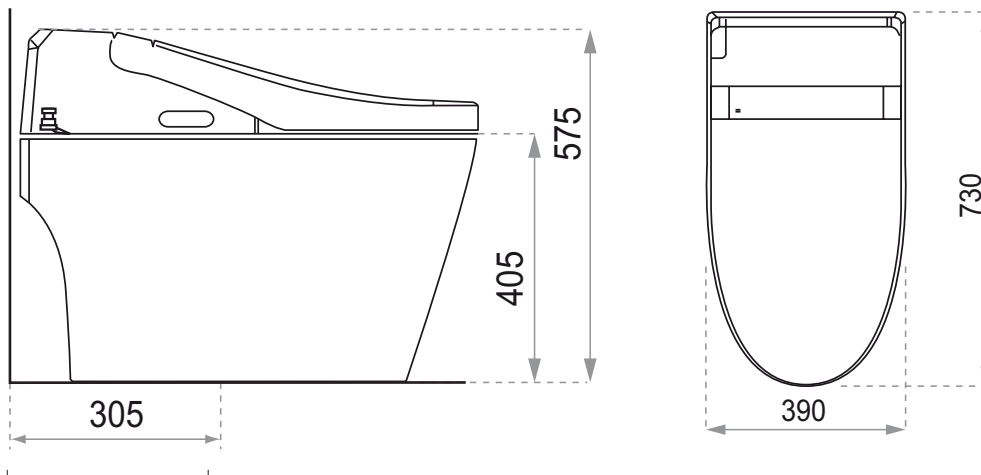

Todas las medidas están en milímetros.

Argentina
Bernardo de Irigoyen 1053 - B1604AFC
Florida - Pcia. de Buenos Aires - Argentina
Tel.: (54 11) 4730-5300 - Fax: (54 11) 4730-5363

www.fvsa.com
 @fvgriferia

export@fvsa.com
 facebook.com/FVGRIFERIA

